

# FAITH PEDESTAL Package #1011308

Includes:

Pan, Soft Close Quick Release Seat M3314B  
TECE Cistern and TECEnow Flush Button  
Variable Set-Out 100-130mm

Suitable for use with all  
TECE Floor Mount Cisterns

Pan Manufactured in PRC  
TECE Manufactured in Germany

2 Years Warranty

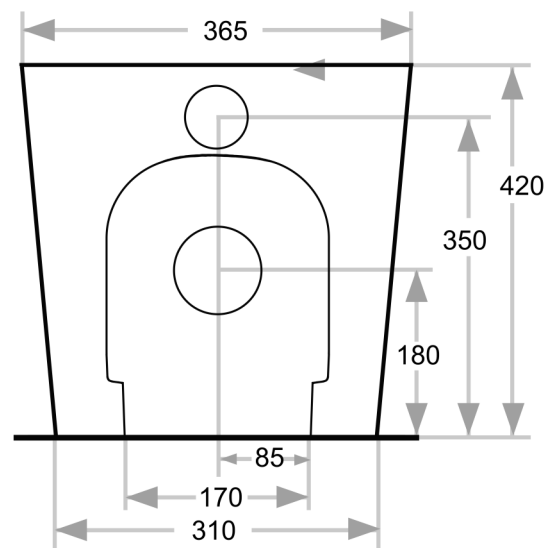
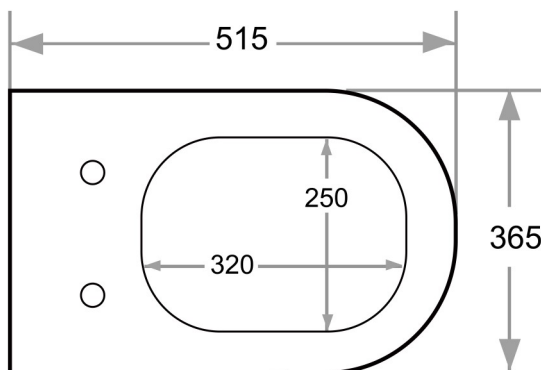
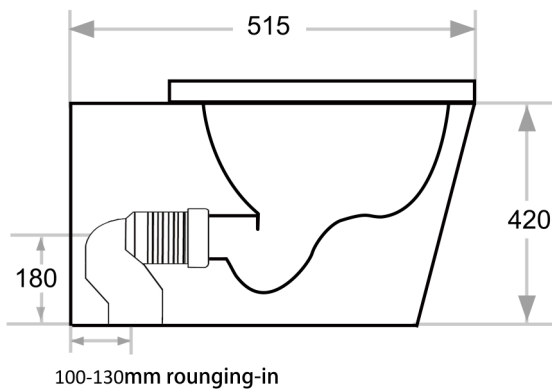

Proudly imported and distributed by  
Gro Agencies Pty Ltd  
Unit 2 / 37 Howe St, Osborne Park, WA, 6017  
P 08 9446 3288 E info@groagencies.com.au W www.groagencies.com.au



## 8cm PEDESTAL CISTERN

Code - 9.370.503

Suitable for use in:  
Double Brick Cavity Walls  
90mm Stud Frame Walls

Front Button Mounting

Sheeting Requirements (Prior to tiling):  
Standard Buttons - 18mm non flex board  
Flush Mount Buttons - 25mm non flex board

**Note:** Square Metal Buttons require **30mm** overall thickness including sheeting & tiling

Water Inlet top left side

2 Year Parts and Labour Warranty on Internals

10 Year Warranty on Cistern Construction

**TECE**  
close to you

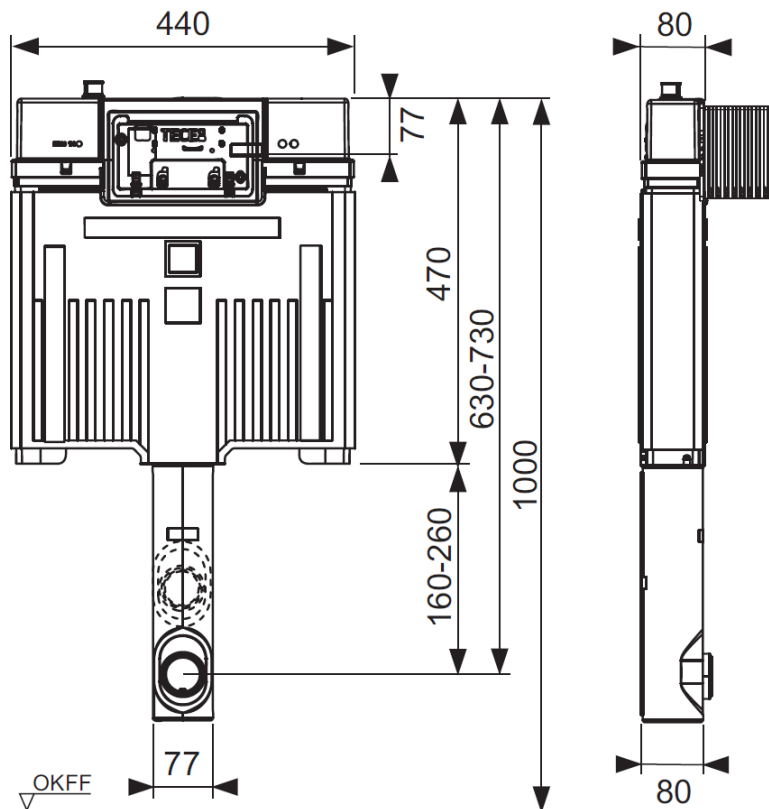
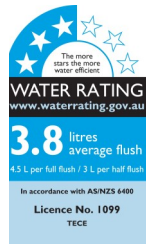
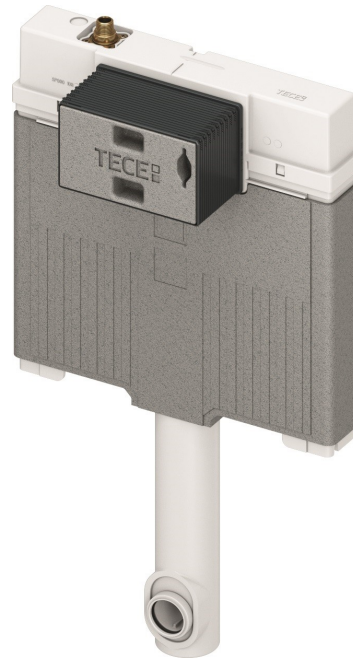

Proudly imported and distributed by  
Gro Agencies Pty Ltd  
Unit 2 / 37 Howe St, Osborne Park, WA, 6017  
P 08 9446 3288 E info@groagencies.com.au W www.groagencies.com.au

**gro**  
agencies

# TECEnow ABS Flush Button

**TECE**  
close to you

Suitable for use with all TECE Cisterns.

Minimum wall thickness for button installation is 18mm (includes sheeting and tiles).

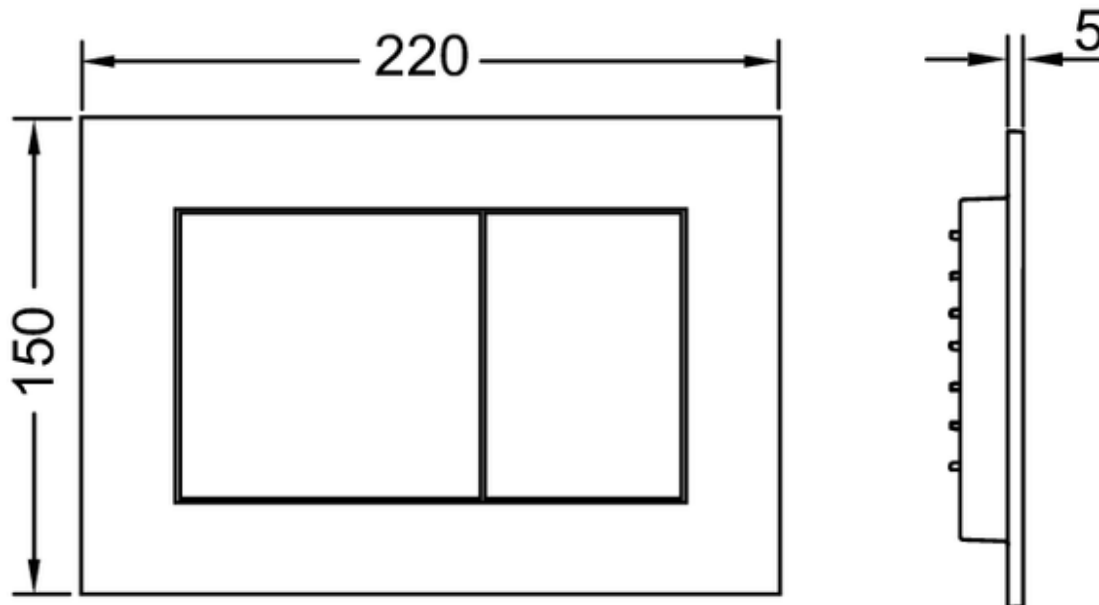
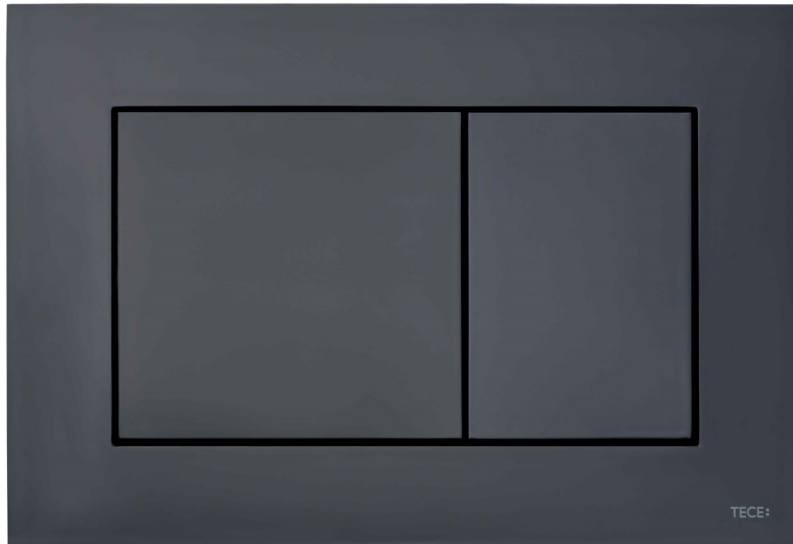

Suitable for use with all TECE Cisterns.

Minimum wall thickness for button installation is 18mm (includes sheeting and tiles).

Proudly imported and distributed by  
Gro Agencies Pty Ltd  
Unit 2 / 37 Howe St, Osborne Park, WA, 6017  
P 08 9446 3288 E [info@groagencies.com.au](mailto:info@groagencies.com.au) W [www.groagencies.com.au](http://www.groagencies.com.au)

**gro**  
agencies