

PRODUCT SPECIFICATIONS

Product	Slimline Tile Insert (STI)
Code	1011649
Colour	Silk Silver
Length	1.0m
Width	100mm
Depth	26mm
Material	Triple Anodised Aluminium
Applications	Indoor and Outdoor
Features	<ul style="list-style-type: none"> • No visible holes • Easy roll out feature • Suitable for tiles up to 11mm thick • Lifetime Rustproof Warranty

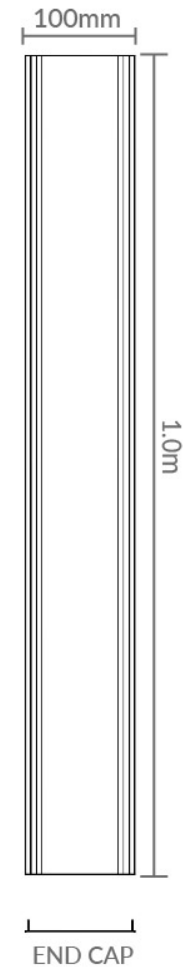

- * Total length is 5.8m, total usable length is 5.6m to allow for any wastage during the anodising process.
- * Each kit comes complete with length of grate, end caps and a waste outlet.
- * Regular, gentle cleaning with soapy water is recommended. Do not use abrasive cloths or acidic chemicals on the grates.

Warranty information and Care & Maintenance can be found at www.lauxesgrates.com.au

Disclaimer: All Lauxes grates and accessories hold WaterMark Certification in accordance with WMTS - 040.

CUTTING INSTRUCTIONS AND INSTALLATION

For ease of cutting Lauxes grates, we recommend using a compound mitre saw fitted with a multi-material cutting blade 80 tooth or more. We also recommend using a Lauxes TCT hole saw to drill the hole for the waste outlet.

1. Cut the bottom tray 3mm shorter than desired length to allow end caps to be fitted.
2. Cut the top grate 1mm shorter than the bottom tray to allow for easy roll-in of top grate and tidy fit.
3. Using a suitable size Lauxes hole saw for your pop waste, drill out the hole at the required position to align with the waste pipe in the floor.
4. Insert the end caps into bottom tray and secure with a bead of silicone on the outside of tray.
5. Place silicone around the lip of the pop waste and secure to the underside of bottom tray at the recently drilled hole.

* During installation use a template to ensure the grate does not come in contact with any wet cement based products.

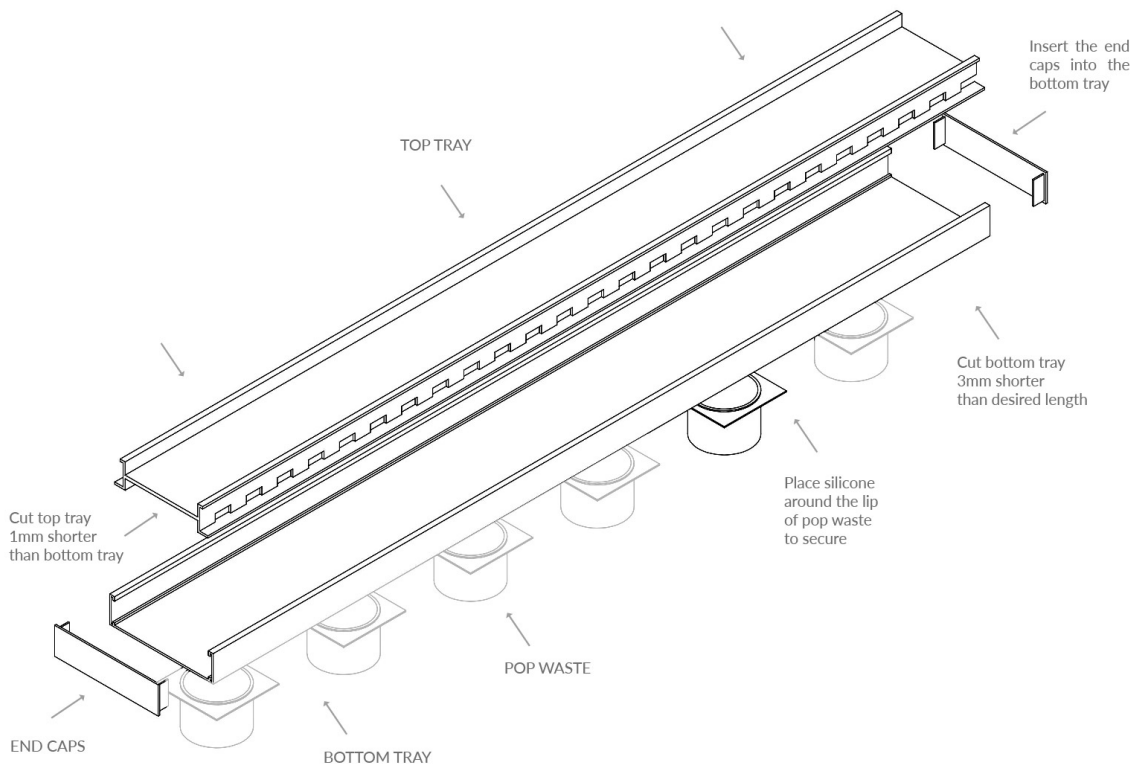

Installation to be by a licensed plumber and in accordance with AS/NZS 3500.2.