



# PHOENIX

## SUTOR

### CHANNEL DRAIN HEELGUARD 75MM OUTLET 65MM

CODE	FINISH	LENGTH
I004661	Stainless Steel	600MM
I004665	Stainless Steel	750MM
I004669	Stainless Steel	900MM
I004673	Stainless Steel	1215MM
I004677	Stainless Steel	1500MM
CODE	FINISH	LENGTH
I004686	Matte Black	600MM
I004690	Matte Black	750MM
I004694	Matte Black	900MM
I004698	Matte Black	1215MM
I004702	Matte Black	1500MM

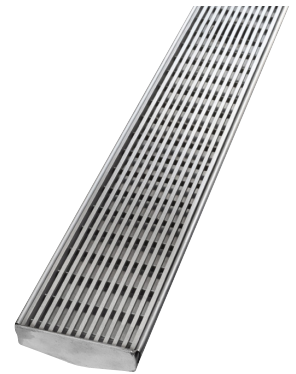

AVAILABLE IN:



STAINLESS STEEL MATTE BLACK

FOR MORE INFORMATION VISIT  
[www.phoenixtapware.com.au](http://www.phoenixtapware.com.au)

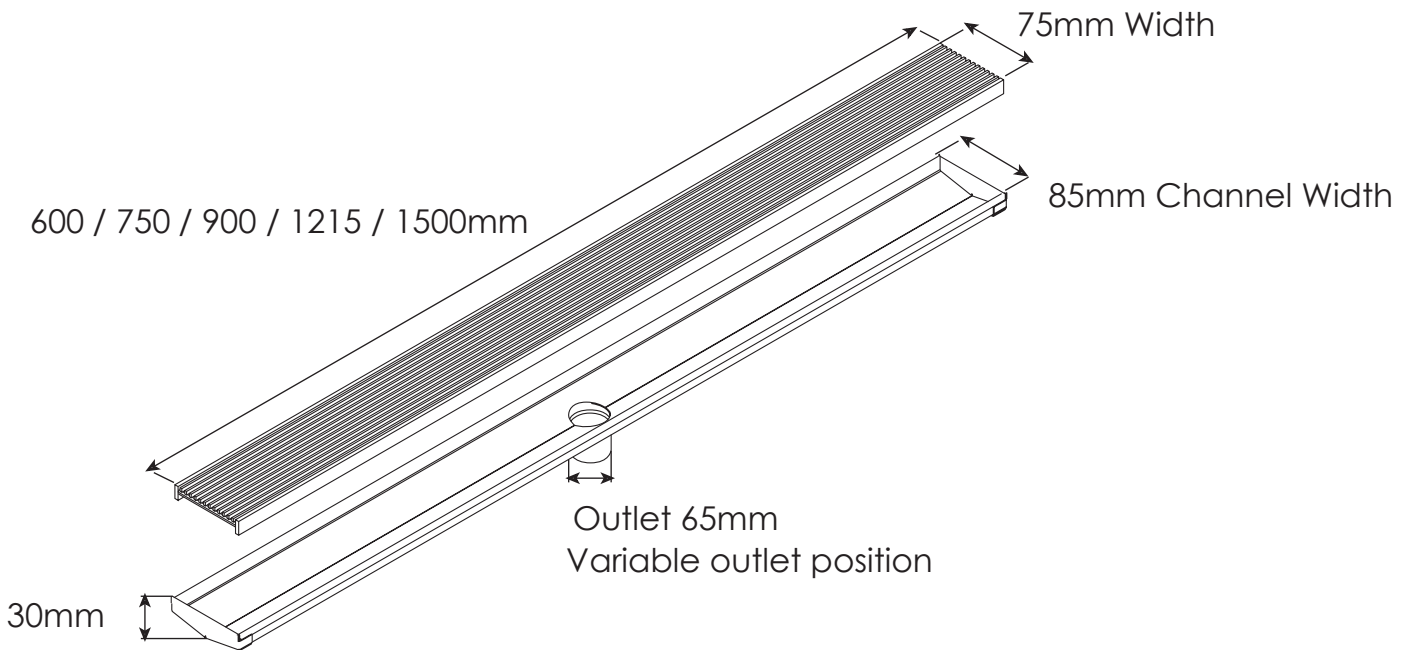

PLEASE [CLICK HERE](#) TO VIEW FULL WARRANTY

While we aim to ensure the specifications shown are correct at time of printing, Phoenix Tapware reserves the right to make modifications without prior notice. Always use the physical product measurements for mark-ups and roughing-in as the line drawing shown may differ from the actual product over time. All measurements are shown in millimetres. Some colours may vary across product types due to differing construction materials. Printed images are a representation only and the colour or finish may vary from the actual product.

[www.phoenixtapware.com.au](http://www.phoenixtapware.com.au)  
03 9780 4200